

Communicating Finite Automata Systems

Bruno Guillon,
Christian Choffrut
cotutelle franco-italienne - Giovanni Pighizzini

L.I.A.F.A, Université Paris Diderot - Paris VII
Dipartimento di Informatica, Università degli studi di Milano

October 10, 2012

Finite Automata

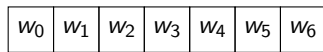

q

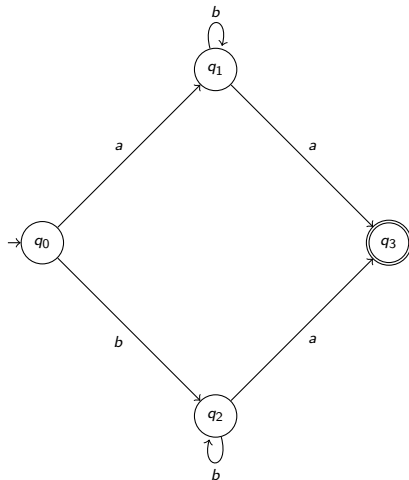

Finite Automata

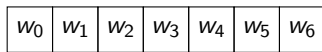

q

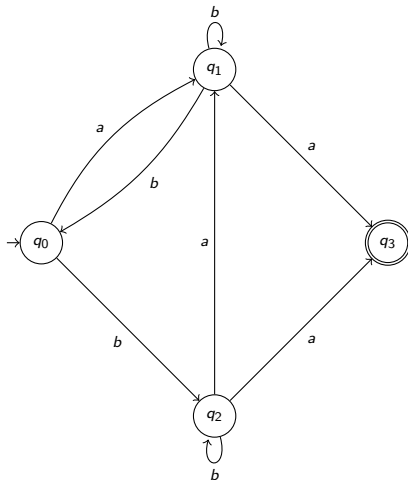

Finite Automata

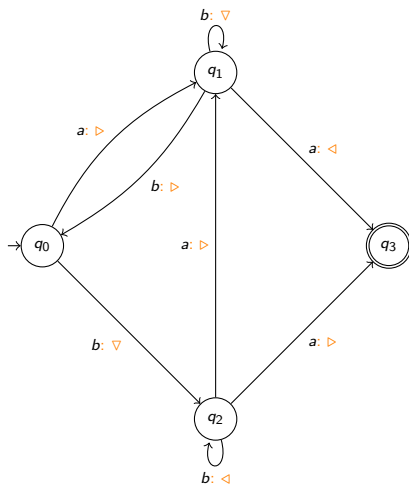
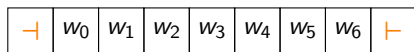

One input, multiple FAs

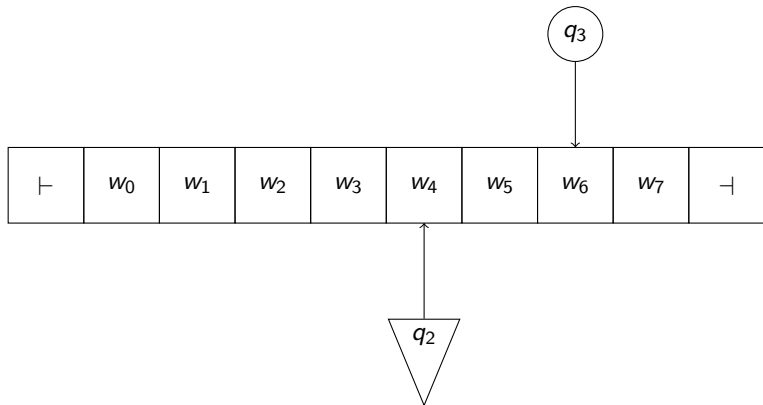

One input, multiple FAs

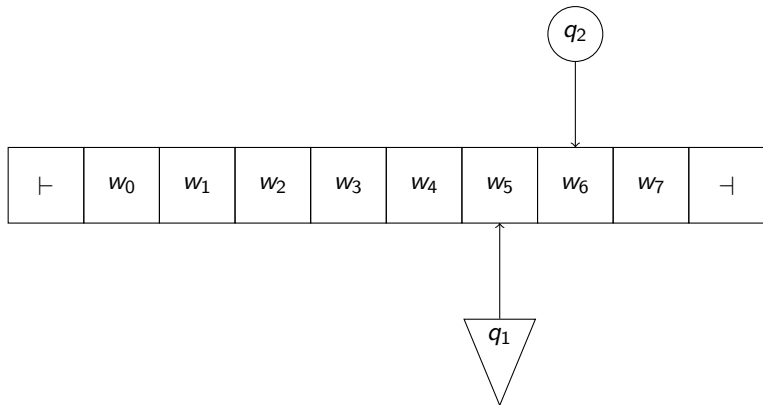

One input, multiple FAs

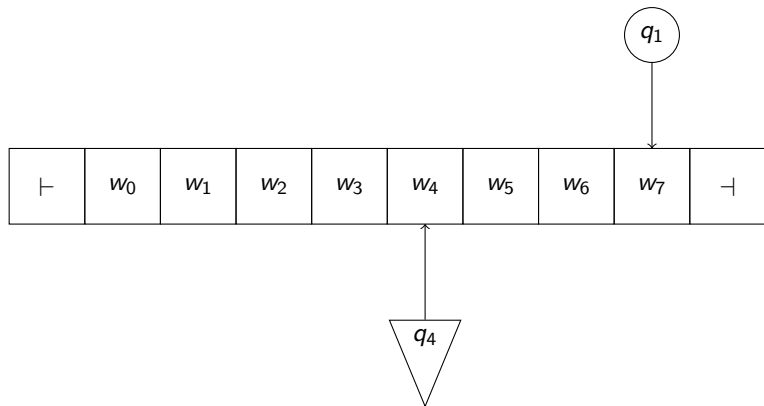

One input, multiple FAs

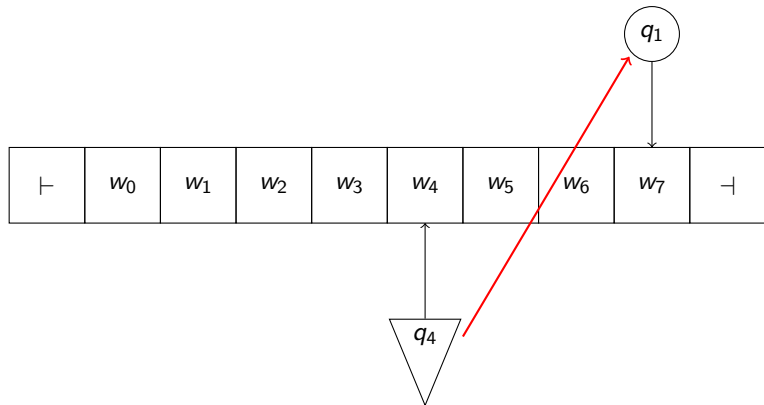

One input, multiple FAs

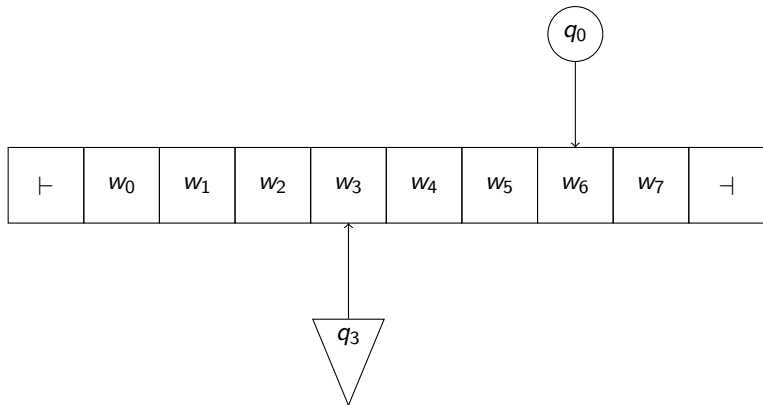

One input, multiple FAs

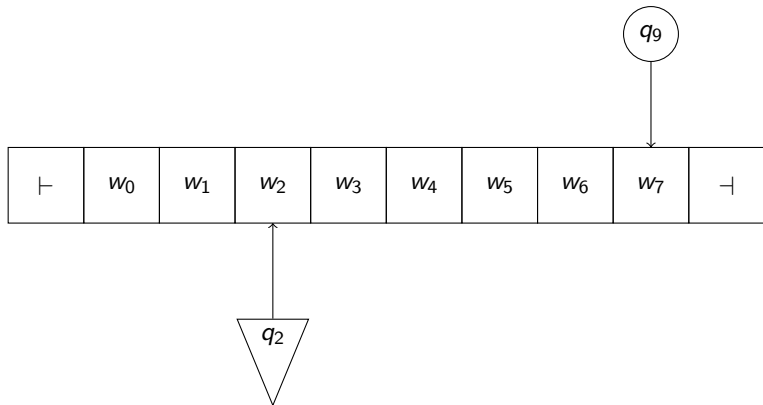

One input, multiple FAs

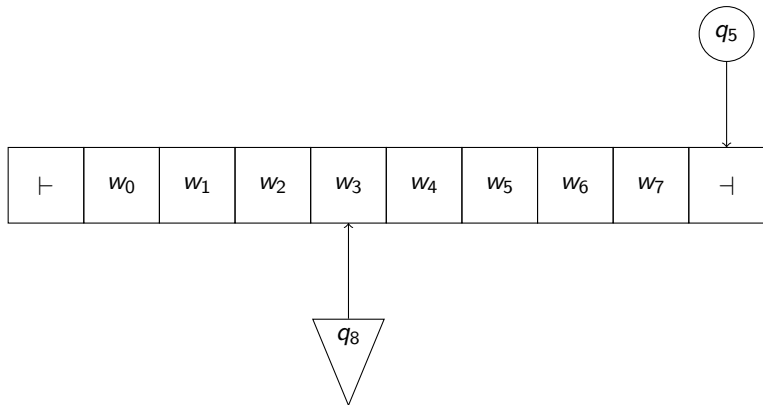

One input, multiple FAs

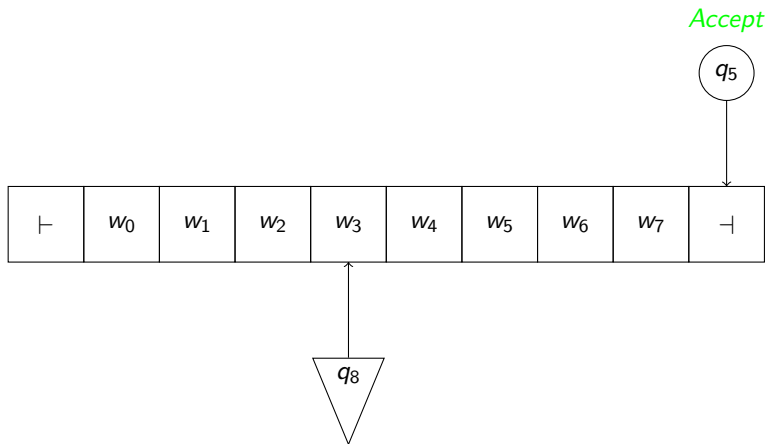

Formally

Each computing step is composed of:

Formally

Each computing step is composed of:

1. send message ?

$$\nu : \Sigma \times Q \rightarrow \{0, 1\}$$

Formally

Each computing step is composed of:

1. send message ?
2. receive message

$$\nu : \Sigma \times Q \rightarrow \{0, 1\}$$

Formally

Each computing step is composed of:

1. send message ?

$$\nu : \Sigma \times Q \rightarrow \{0, 1\}$$

2. receive message

3. execute transition: $\delta : Q \times \Sigma \times M \rightarrow \mathcal{P}(Q \times \{-1, 0, +1\})$,

$$\text{where } M = (Q \cup \{Nil\})^k.$$

Formally

Each computing step is composed of:

1. send message ? $\nu : \Sigma \times Q \rightarrow \{0, 1\}$
2. receive message
3. execute transition: $\delta : Q \times \Sigma \times M \rightarrow \mathcal{P}(Q \times \{-1, 0, +1\})$,

where $M = (Q \cup \{Nil\})^k$.

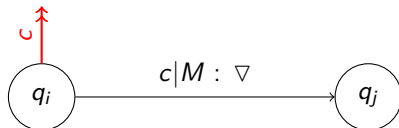

Example

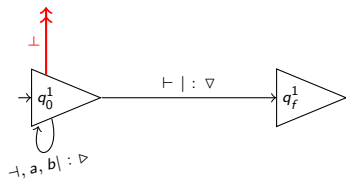
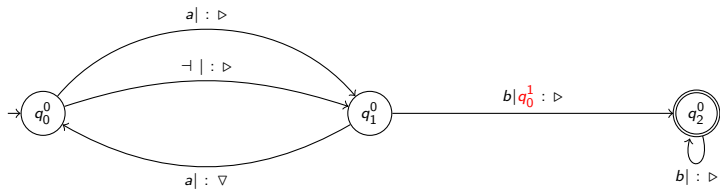

Example

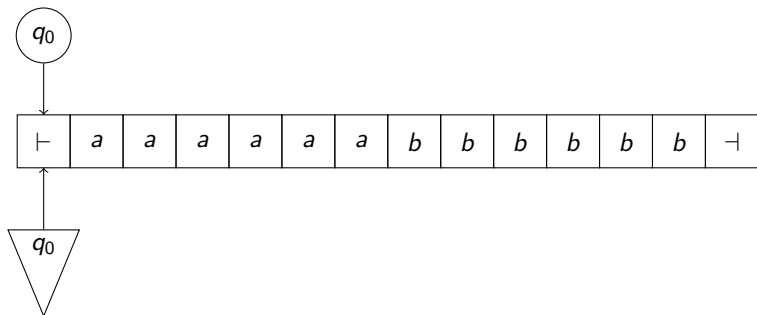

Example

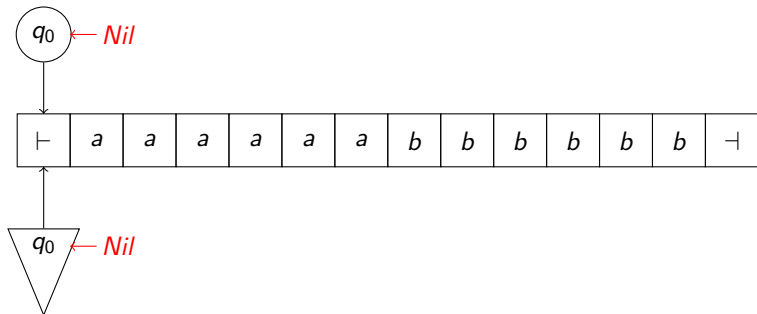

Example

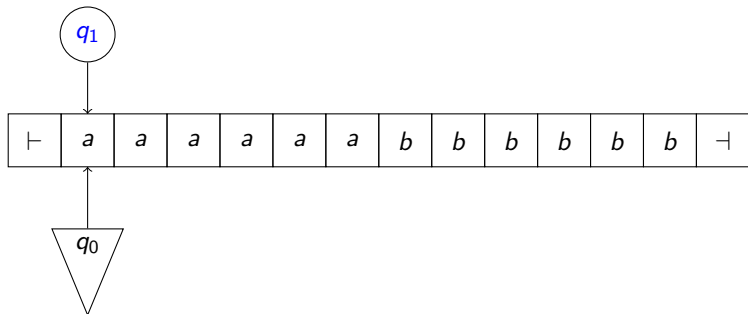

Example

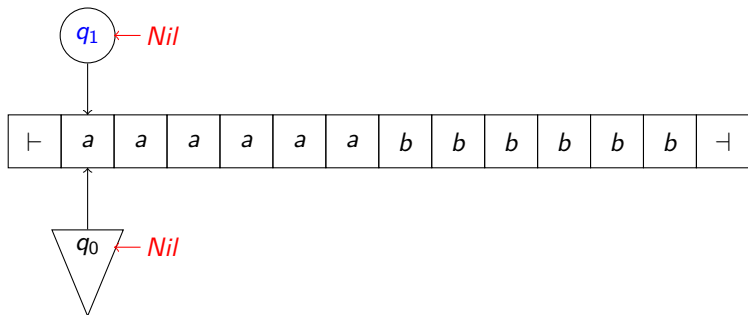

Example

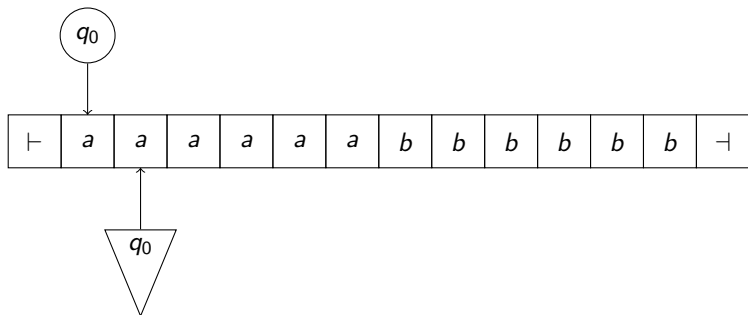

Example

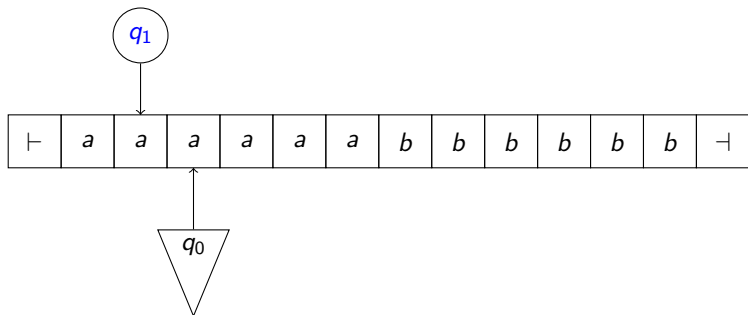

Example

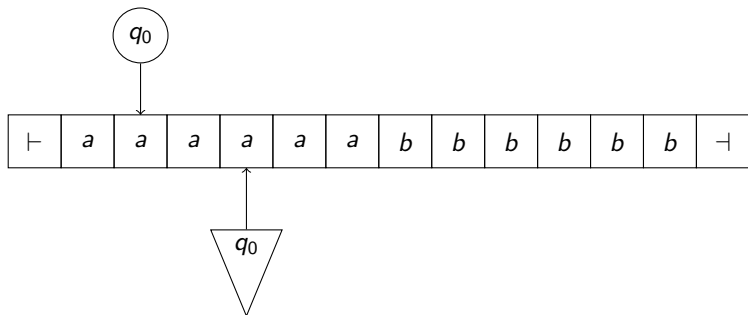

Example

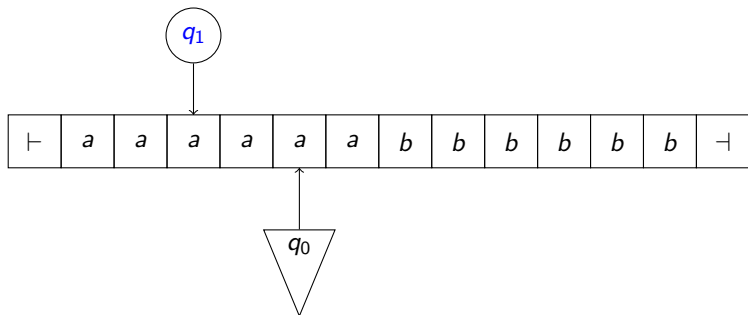

Example

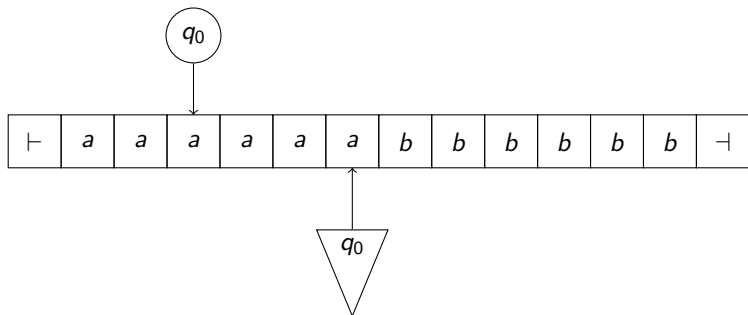

Example

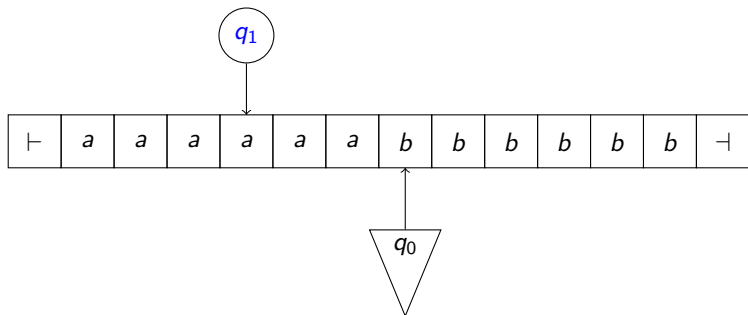

Example

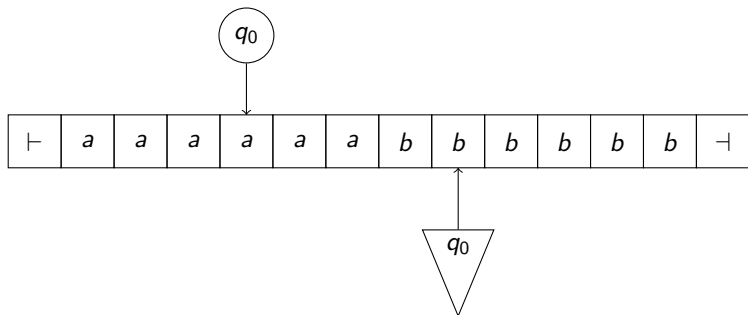

Example

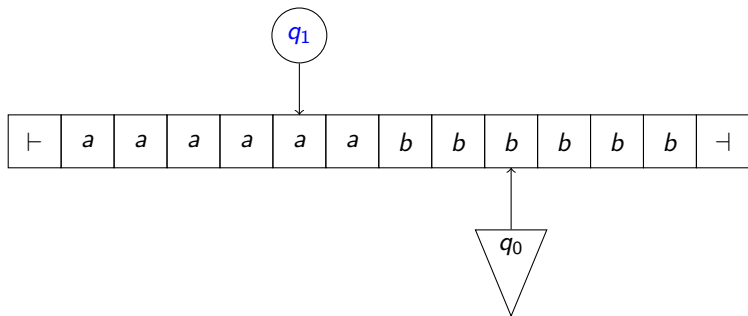

Example

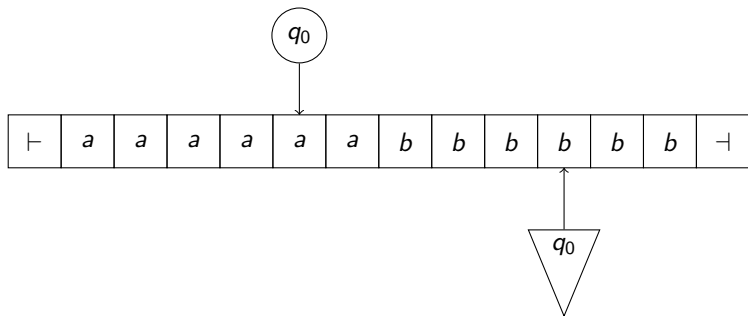

Example

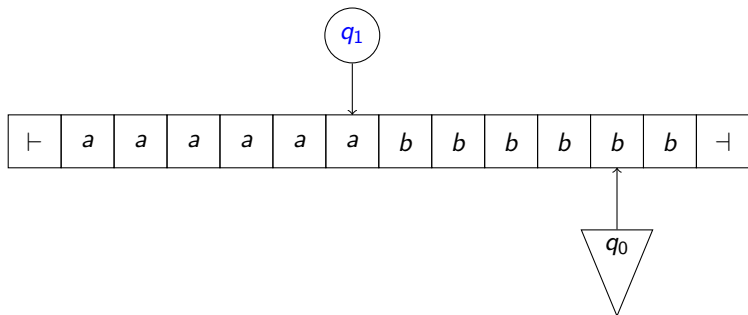

Example

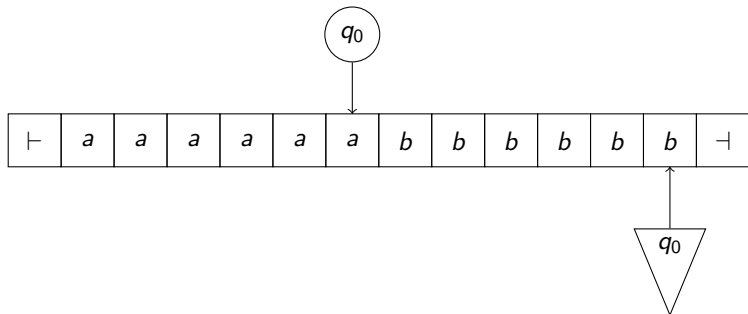

Example

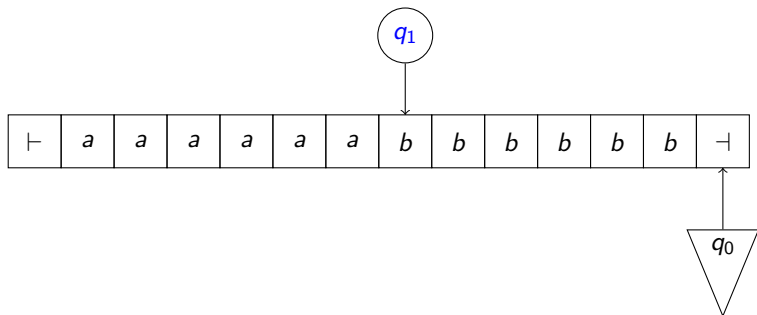

Example

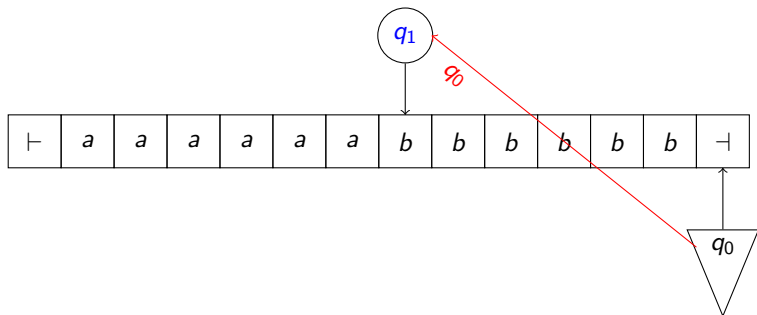

Example

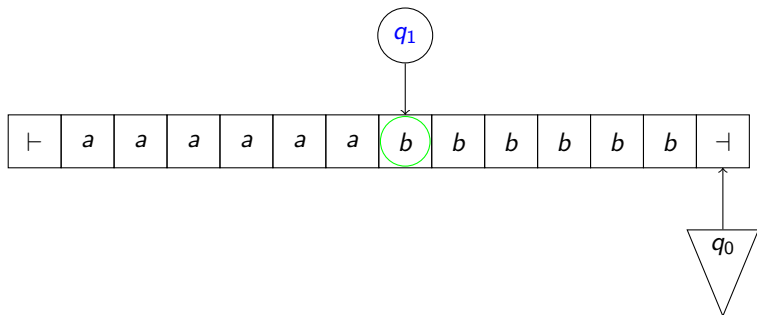

Example

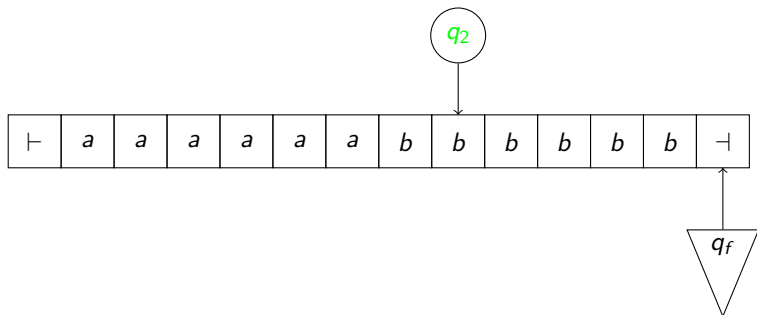

Example

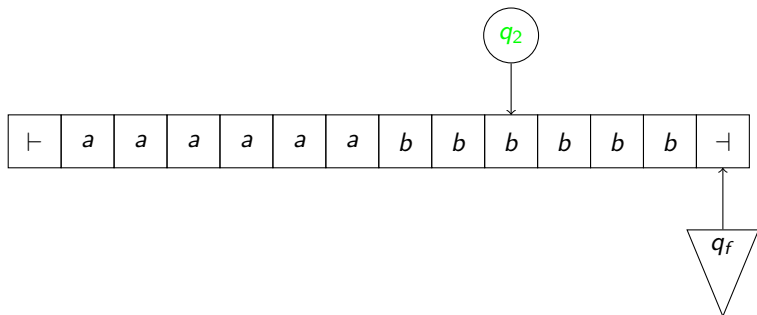

Example

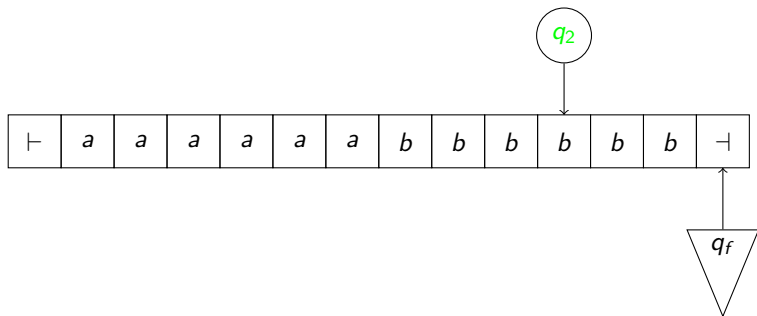

Example

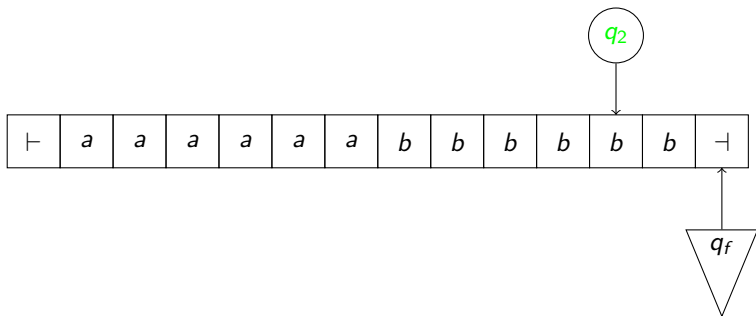

Example

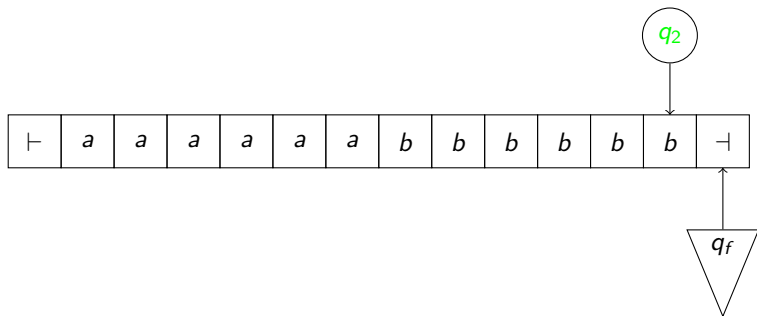

Example

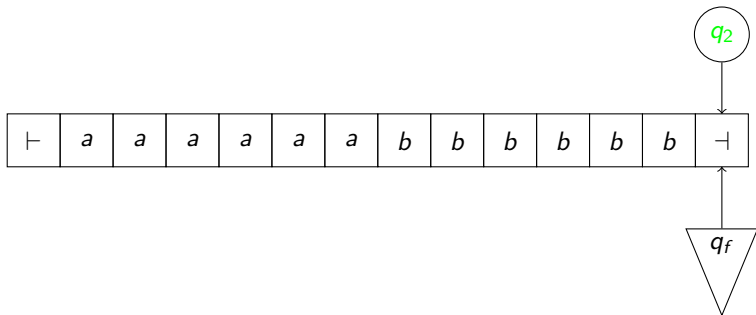

Example

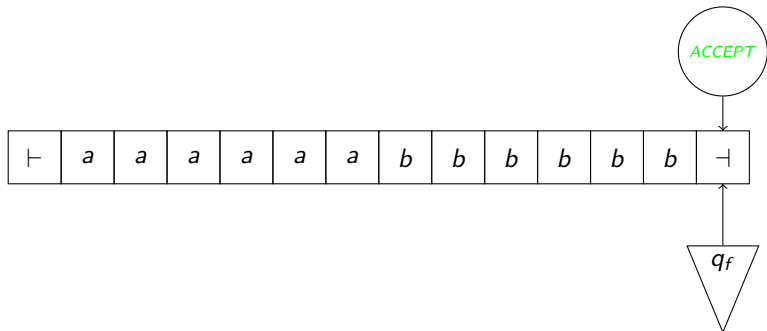

Example

accepted language $\{a^n b^n\}$

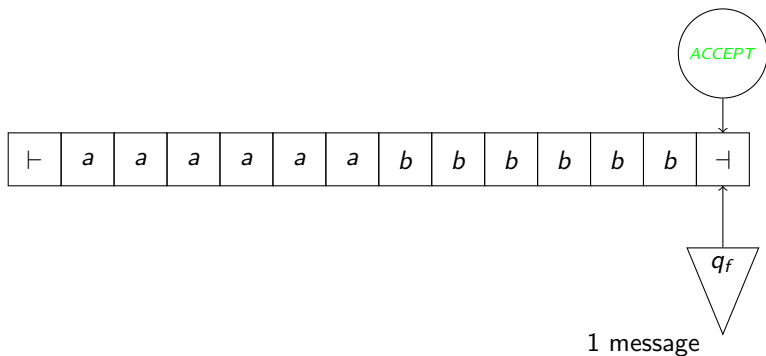

Over unary alphabets?

Over unary alphabets?

One may accept $\{1^{2^n}, n \in \mathbb{N}\}$:

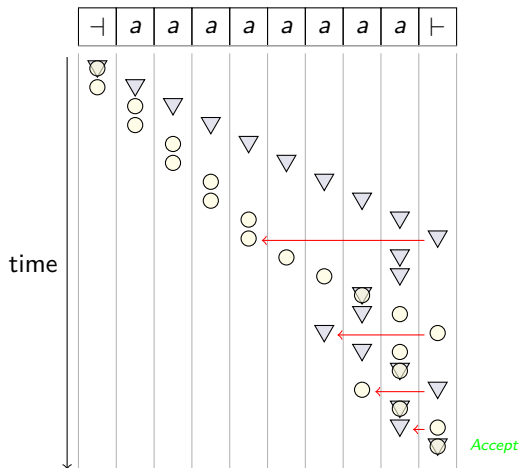

Previous results

Theorems (Tomasz Jurdzinski, 1999-2001)

Notation: $dMes_k(f)$

Previous results

Theorems (Tomasz Jurdzinski, 1999-2001)

Notation: $dMes_k(f)$

- ▶ $1Mes_k(m+1) \setminus 2Mes_k(m) \neq \emptyset$

Previous results

Theorems (Tomasz Jurdzinski, 1999-2001)

Notation: $dMes_k(f)$

- ▶ $1Mes_k(m+1) \setminus 2Mes_k(m) \neq \emptyset$
- ▶ $2Mes_2(m+1) \setminus 2Mes_k(m) \neq \emptyset$

Previous results

Theorems (Tomasz Jurdzinski, 1999-2001)

Notation: $dMes_k(f)$

- ▶ $1Mes_k(m+1) \setminus 2Mes_k(m) \neq \emptyset$
- ▶ $2Mes_2(m+1) \setminus 2Mes_k(m) \neq \emptyset$
- ▶ $1Mes_k(o(\log n)) = 1Mes_k(\mathcal{O}(1))$

Previous results

Theorems (Tomasz Jurdzinski, 1999-2001)

Notation: $dMes_k(f)$

- ▶ $1Mes_k(m+1) \setminus 2Mes_k(m) \neq \emptyset$
- ▶ $2Mes_2(m+1) \setminus 2Mes_k(m) \neq \emptyset$
- ▶ $1Mes_k(o(\log n)) = 1Mes_k(\mathcal{O}(1))$
- ▶ $2Mes_k(o((\log \log \log n)^c)) = 2Mes_k(\mathcal{O}(1))$

Conjecture

Question

Which language may be accepted by Communicating FA

Conjecture

Question

Which language may be accepted by Communicating FA, over unary alphabets

Conjecture

Question

*Which language may be accepted by Communicating FA,
over unary alphabets,
with a constant number of messages?*

Conjecture

Question

*Which language may be accepted by Communicating FA,
over unary alphabets,
with a constant number of messages?*

Conjecture

unary rational languages.

Conjecture

Question

*Which language may be accepted by Communicating FA,
over unary alphabets,
with a constant number of messages?*

Conjecture

unary rational languages.

- ▶ one-way/two-way

Conjecture

Question

*Which language may be accepted by Communicating FA,
over unary alphabets,
with a constant number of messages?*

Conjecture

unary rational languages.

- ▶ one-way/two-way
- ▶ deterministic/nondeterministic

Conjecture

Question

Which language may be accepted by Communicating FA, over unary alphabets, with a constant number of messages?

Conjecture

unary rational languages.

- ▶ **one-way**/two-way
- ▶ **deterministic**/nondeterministic

Theorem (Harrison & Ibarra, 1968)

Unary one-way multihead automata accept exactly regular languages.

Conjecture

Question

*Which language may be accepted by Communicating FA,
over unary alphabets,
with a constant number of messages?*

Conjecture

unary rational languages.

- ▶ one-way/**two-way**
- ▶ **deterministic/nondeterministic**

Conjecture

Question

*Which language may be accepted by Communicating FA,
over unary alphabets,
with a constant number of messages?*

Conjecture

unary rational languages.

- ▶ one-way/**two-way**
- ▶ **deterministic**/**nondeterministic**

Other questions, future work. . .

- ▶ Does there exist a gap in the number of messages in the unary case (conjecture: $\log(n)/\text{constant}$)

Recall (Jurdzinski)

General case: $2\text{Mes}_k(o((\log \log \log n)^c)) = 2\text{Mes}_k(\mathcal{O}(1))$

Other questions, future work. . .

- ▶ Does there exist a gap in the number of messages in the unary case (conjecture: $\log(n)/\text{constant}$)
- ▶ Influence of nondeterminism (in general case)

Example

non regular language: $\{1^n \# 1^m, / \gcd(n, m) = 1\}$ is accepted by nondeterministic $2Mes_2(1)$.

Other questions, future work. . .

- ▶ Does there exist a gap in the number of messages in the unary case (conjecture: $\log(n)/\text{constant}$)
- ▶ Influence of nondeterminism (in general case)

Example

non regular language: $\{1^n \# 1^m, / \gcd(n, m) = 1\}$ is accepted by nondeterministic $2Mes_2(1)$.

Other questions, future work. . .

- ▶ Does there exist a gap in the number of messages in the unary case (conjecture: $\log(n)/\text{constant}$)
- ▶ Influence of nondeterminism (in general case)

Example

non regular language: $\{1^n \# 1^m, / \gcd(n, m) = 1\}$ is accepted by nondeterministic $2Mes_2(1)$.

Thanks for your attention. . .