

3466
E: Padding
Bead I0

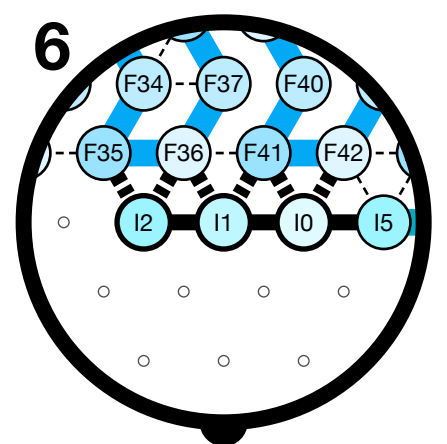

3467
E: Padding
Bead I1

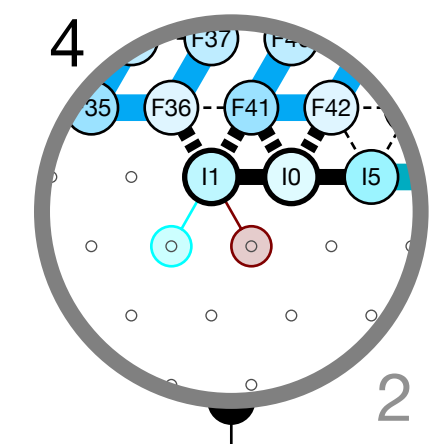
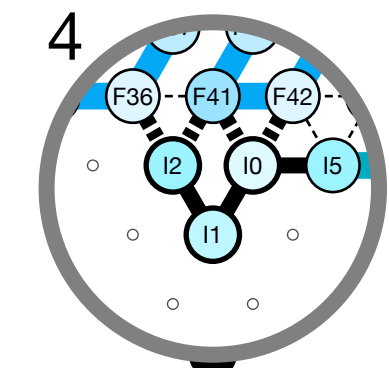
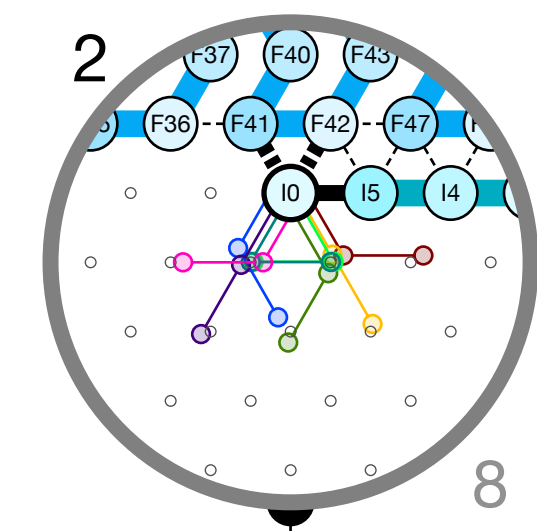
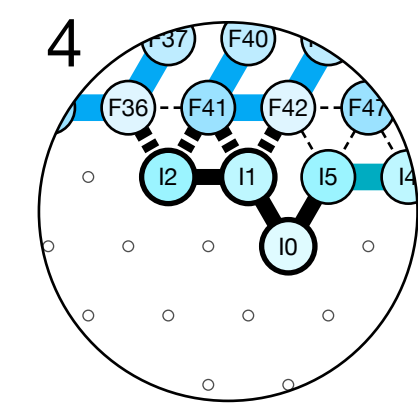
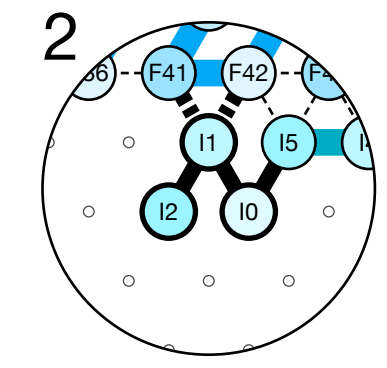
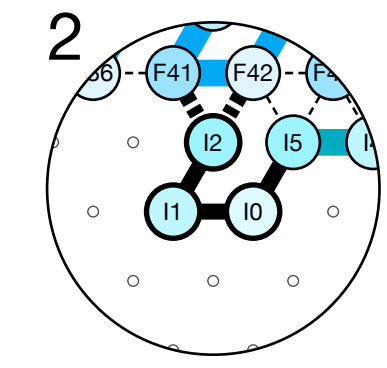
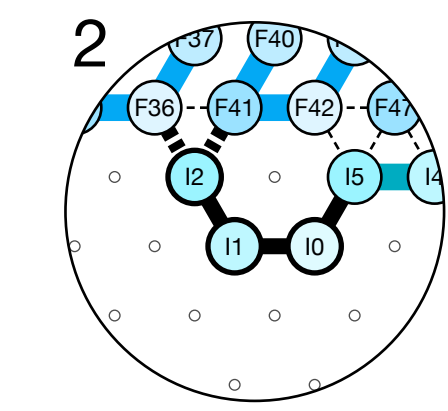
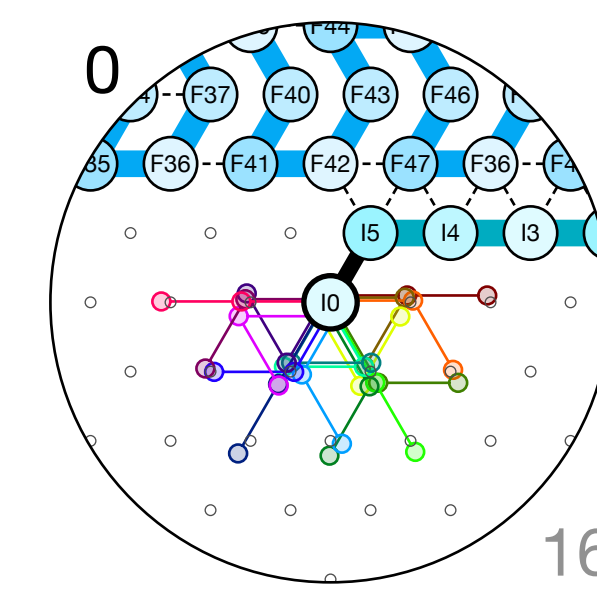
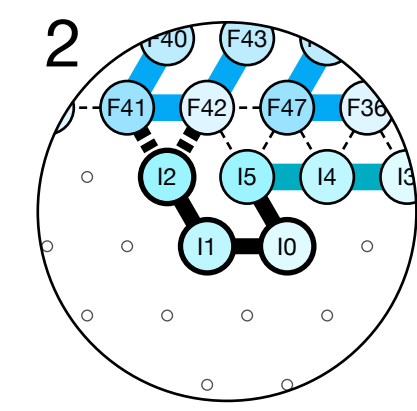
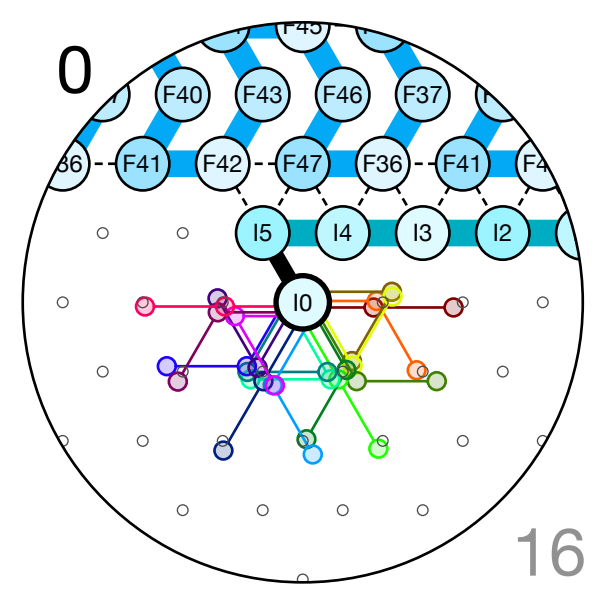
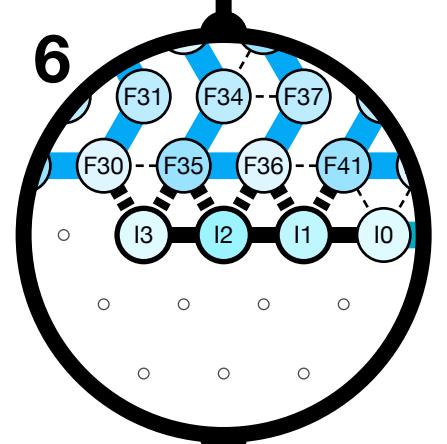
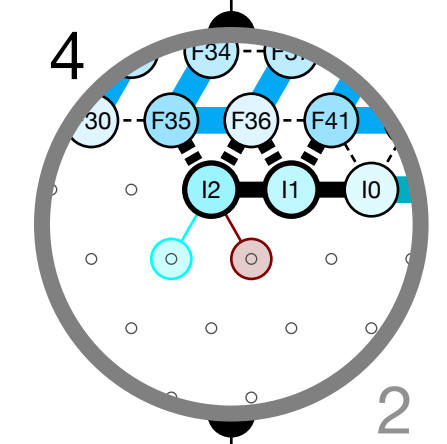
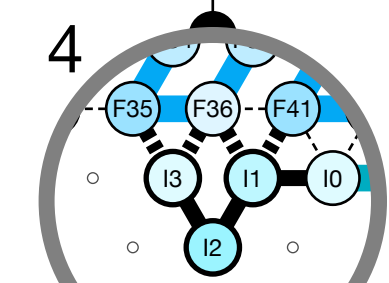
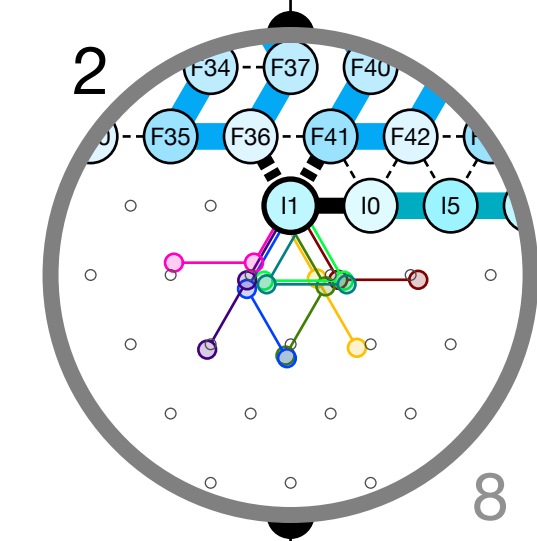
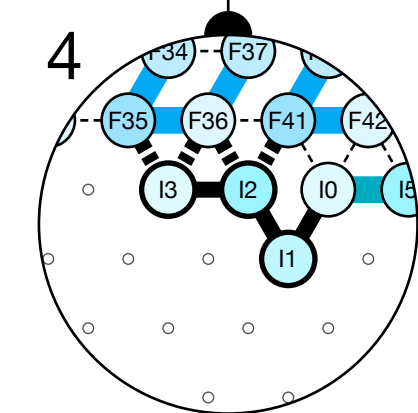
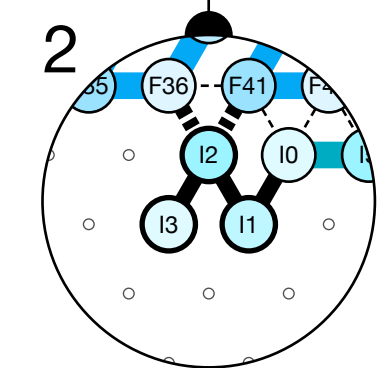
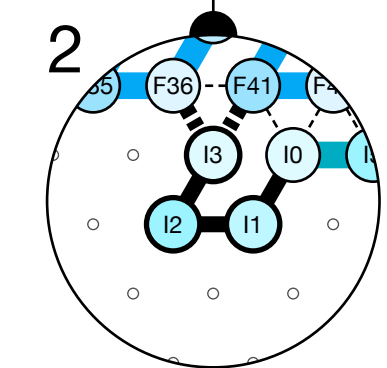
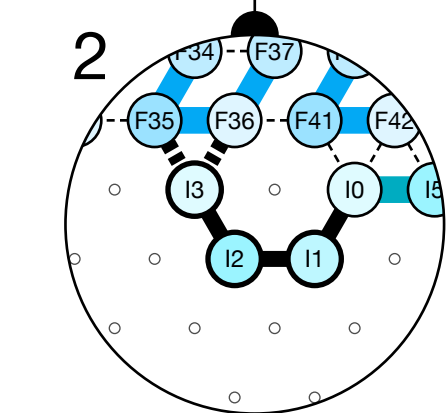
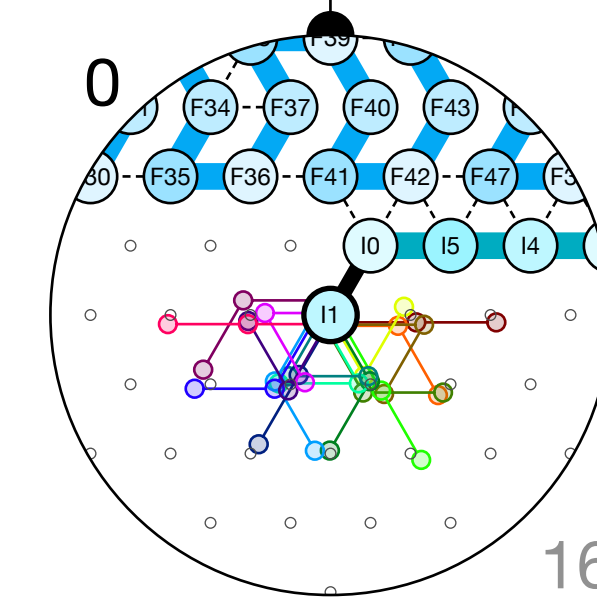
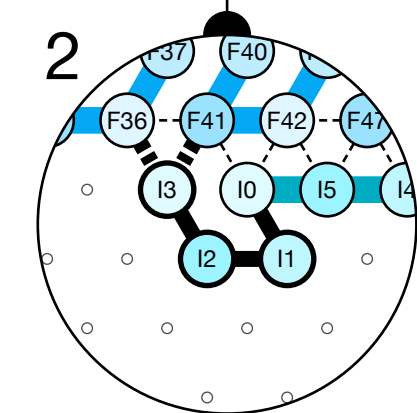
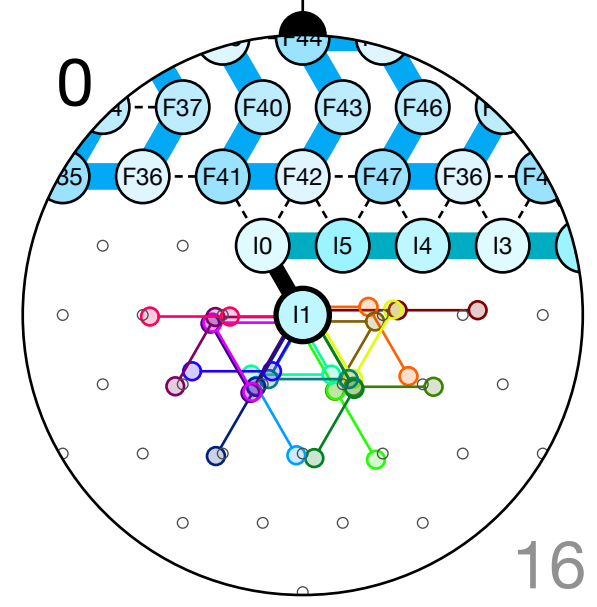

3468
E: Padding
Bead I2

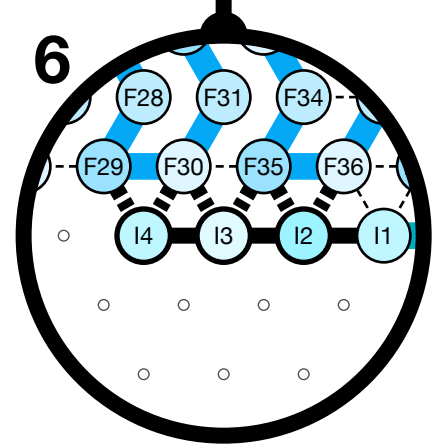
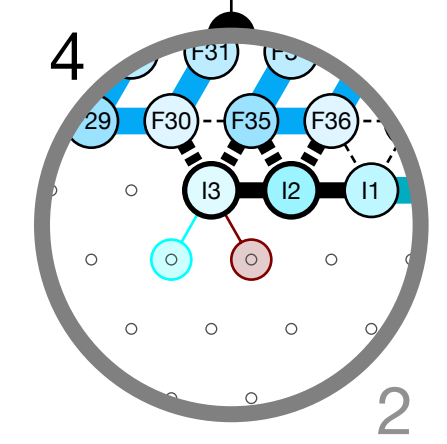
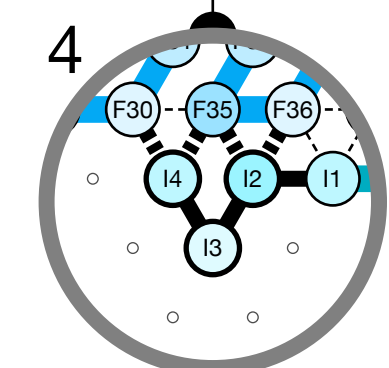
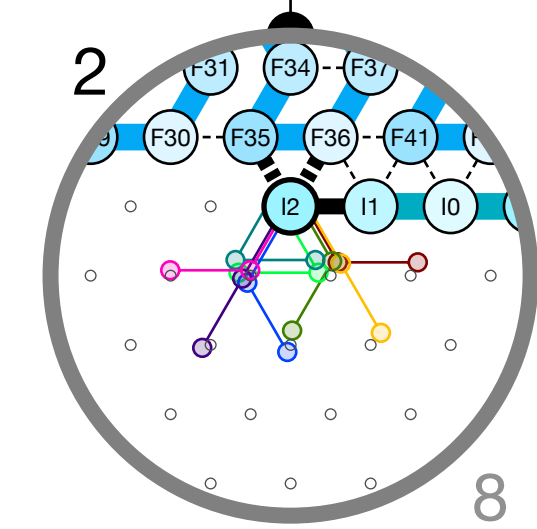
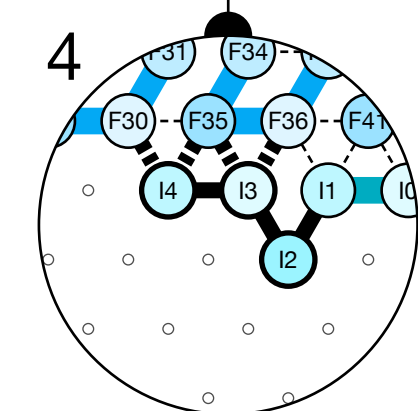
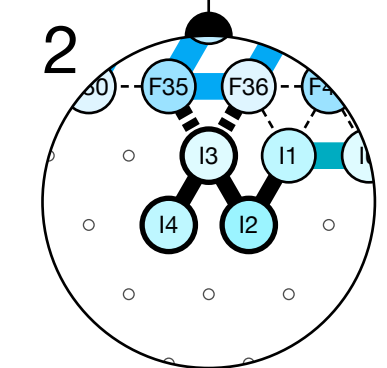
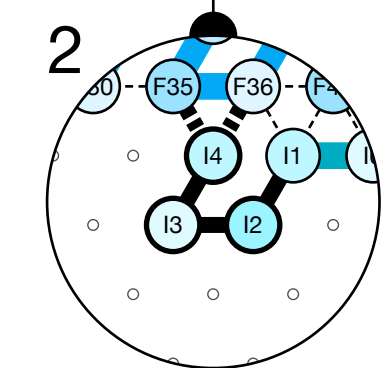
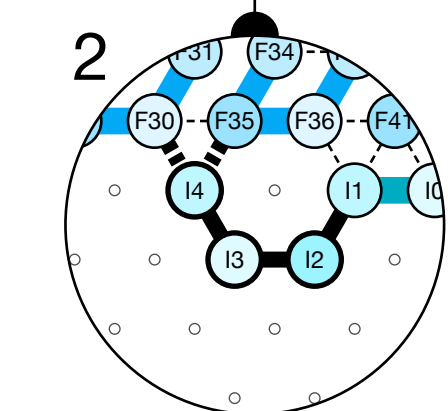
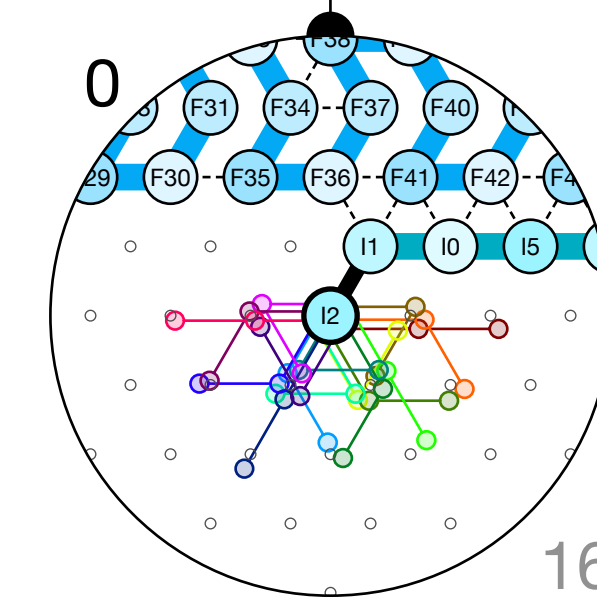
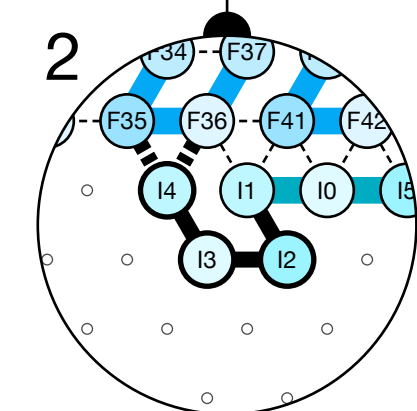
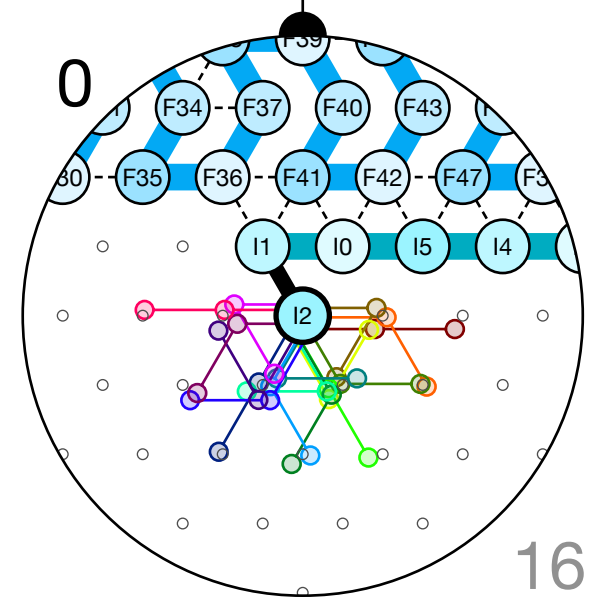

Next: # 3411